

Flange Connection

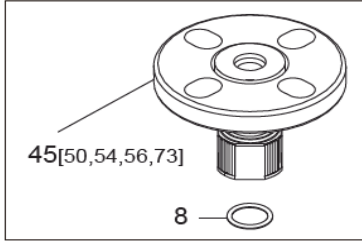

GF Connection

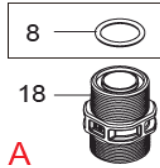

NPT Connection

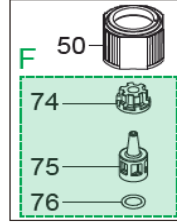
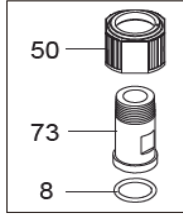

Tubing Connection

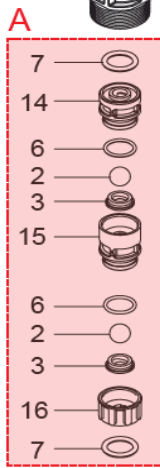
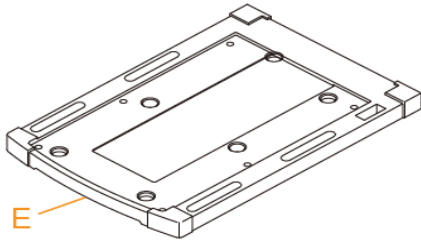

NO.	DESCRIPTION	QTY
A	Valve set	2
D	Diaphragm set	1
E	Base	1
F	Connector set	2
1	Pump head	1
2	Valve	4
3	Valve seat	4
6	O-ring	4
7	O-ring	4
8	O-ring	2
14	Valve guide A	2
15	Valve guide B	2
16	Seat holder	2
17	IN Adapter	1
18	OUT Adapter	1
19	Hex socket head bolt	4
20	Spring washer	4
21	Plain washer	4
28	Bolt cover	1
30	Diaphragm unit	1
31	Retainer	1
32	Diaphragm sheet	1
33	Diaphragm stopper	1
34	Gasket	1
35	Bracket spacer	1
45	Flange unit	2
50	Nut	2
54	Flange	2
56	Flange adapter	2
73	Fitting	2
74	Hose stopper	2
75	Hose adapter	2
76	O-ring	2

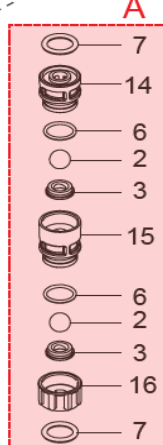
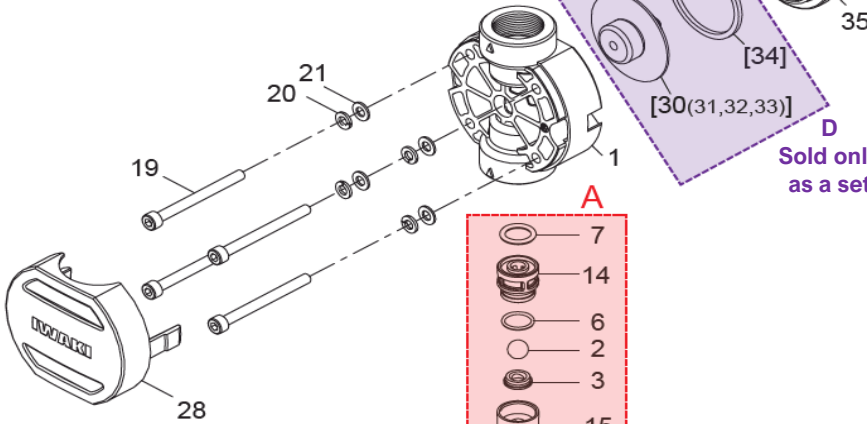

Sold only as a set

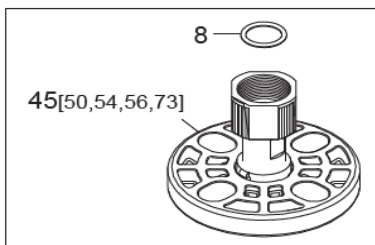

Flange Connection

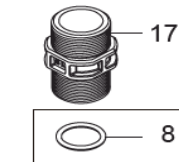

GF Connection

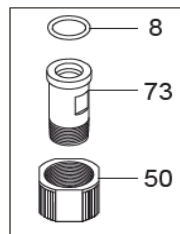

NPT Connection

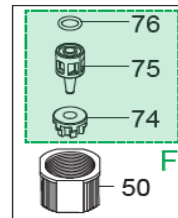

Tubing Connection

NOTES:

1. Actual parts may differ from the illustration.
2. Individual parts shown in "[]" are not available - they are part of an assembly.
3. The GF (George Fischer) connection is part of the NPT connection model code.

IX-B030/45TC/TE Pumps

NO.	DESCRIPTION	MODEL CODE	MATERIAL	SIZE	QTY	CODE	ITEM NOS.	IN SPARE PARTS KIT
1	Pump head		PVDF		1	IX0299		
2	Valve		AL CE	1/2"	4	IX0047		*
3	Valve seat	TC	FKM		4	IX0049		*
		TE	EPDM		4	IX0050		*
6	O-ring	TC	FKM	S-20	4	IX0300		*
		TE	EPDM	S-20	4	IX0301		*
7	O-ring	TC	FKM	P-14	4	IX0302		*
		TE	EPDM	P-14	4	IX0303		*
8	O-ring	TCN / TCFA	FKM	P-18	2	IX0256		*
		TEN / TEFA	EPDM	P-18	2	IX0257		*
14	Valve guide A		PVDF		2	IX0304		*
15	Valve guide B		PVDF		2	IX0305		*
16	Seat holder		PVDF		2	IX0306		*
A	Valve set	TC			2	IX0319	(2,3,6,7,14,15,16)	
		TE			2	IX0320	(2,3,6,7,14,15,16)	
17	IN Adapter		PVDF		1	IX0307		
18	OUT Adapter		PVDF		1	IX0308		
19	Hex soc head bolt		SS	M5x60	4	IX0309		
20	Spring washer		SS	M5	4	IX0264		
21	Plain washer		SS	M5	4	IX0265		
28	Bolt cover		PPE		1	IX0310		
D	Diaphragm set		PTFE/PVDF		1	IX0321	(30,34)	*
35	Bracket spacer		GFRPP		1	IX0313		
45	Flange unit	TCFA / TEFA			2	IX0270	(50,54,56,73)	
50	Nut	TCN / TEN	GFRPP		2	IX0271		
		TCT / TET	GFRPP		2	IX0272		
73	Fitting	TCN / TEN	PVDF	1/2-14NPT	2	IX0274		
74	Hose stopper	TCT / TET	PPS	3/8 x 1/2 T	2	IX0315		*
75	Hose adapter	TCT / TET	PVDF	3/8 x 1/2 T	2	IX0318		*
76	O-ring	TCT	FKM	P-9	2	IX0281		*
		TET	EPDM	P-9	2	IX0282		*
E	Base		GFRPP		1	IX0333		
F	Connector set	TCT		3/8"x1/2"	2	IX0328	(74,75,76)	
		TET		3/8"x1/2"	2	IX0329	(74,75,76)	